

The RF Line

NPN Silicon

RF Power Transistor

MRF857S

Designed for 24 Volt UHF large-signal, common emitter, class A linear amplifier applications in industrial and commercial equipment operating in the range of 800–960 MHz.

- Specified for $V_{CE} = 24$ Vdc, $I_C = 0.3$ Adc Characteristics
 - Output Power = 2.1 Watts CW
 - Minimum Power Gain = 12.5 dB
 - Minimum ITO = +43 dBm
 - Typical Noise Figure = 5.25 dB
- Characterized with Small-Signal S-Parameters and Series Equivalent Large-Signal Parameters from 800–960 MHz
- Silicon Nitride Passivated
- 100% Tested for Load Mismatch Stress at All Phase Angles with 30:1 VSWR @ 24 Vdc, $I_C = 0.3$ Adc and Rated Output Power
- Will Withstand RF Input Overdrive of 0.4 W CW
- Gold Metallized, Emitter Ballasted for Long Life and Resistance to Metal Migration
- Circuit board photomaster available upon request by contacting RF Tactical Marketing in Phoenix, AZ.

CLASS A
800–960 MHz
2.1 W (CW), 24 V
NPN SILICON
RF POWER TRANSISTOR



CASE 305D-01, STYLE 1

MAXIMUM RATINGS

Rating	Symbol	Value	Unit
Collector–Emitter Voltage	V_{CEO}	30	Vdc
Collector–Base Voltage	V_{CBO}	55	Vdc
Emitter–Base Voltage	V_{EBO}	4	Vdc
Total Device Dissipation @ $T_C = 50^\circ\text{C}$ Derate above 50°C	P_D	17 0.114	Watts W/ $^\circ\text{C}$
Operating Junction Temperature	T_J	200	$^\circ\text{C}$
Storage Temperature Range	T_{stg}	–65 to +150	$^\circ\text{C}$

THERMAL CHARACTERISTICS

Characteristic	Symbol	Max	Unit
Thermal Resistance ($T_J = 150^\circ\text{C}$, $T_C = 50^\circ\text{C}$)	$R_{\theta JC}$	8.4	$^\circ\text{C}/\text{W}$

ELECTRICAL CHARACTERISTICS

Characteristic	Symbol	Min	Typ	Max	Unit
----------------	--------	-----	-----	-----	------

OFF CHARACTERISTICS

Collector–Emitter Breakdown Voltage ($I_C = 20$ mA, $I_B = 0$)	$V_{(BR)CEO}$	28	35	—	Vdc
Collector–Emitter Breakdown Voltage ($I_C = 20$ mA, $V_{BE} = 0$)	$V_{(BR)CES}$	55	85	—	Vdc
Collector–Base Breakdown Voltage ($I_C = 20$ mA, $I_E = 0$)	$V_{(BR)CBO}$	55	85	—	Vdc
Emitter–Base Breakdown Voltage ($I_E = 1$ mA, $I_C = 0$)	$V_{(BR)EBO}$	4	5	—	Vdc
Collector Cutoff Current ($V_{CB} = 24$ V, $I_E = 0$)	I_{CES}	—	—	1	mA

(continued)



ELECTRICAL CHARACTERISTICS — continued

Characteristic	Symbol	Min	Typ	Max	Unit
ON CHARACTERISTICS					
DC Current Gain ($I_C = 0.1$ A, $V_{CE} = 5$ V)	h_{FE}	30	60	120	—
DYNAMIC CHARACTERISTICS					
Output Capacitance ($V_{CB} = 24$ V, $f = 1$ MHz)	C_{ob}	2.4	3.3	4.4	pF
FUNCTIONAL CHARACTERISTICS					
Common-Emitter Power Gain ($V_{CE} = 24$ V, $I_C = 0.3$ A, $f = 840$ – 900 MHz, Power Output = 2.1 W)	P_g	12.5	13.5	—	dB
Load Mismatch ($P_O = 2.1$ W) ($V_{CE} = 24$ V, $I_C = 0.3$ A, $f = 840$ MHz, Load VSWR = 30:1, All Phase Angles)	ψ	No Degradation in Output Power			
RF Input Overdrive ($V_{CE} = 24$ V, $I_C = 0.3$ A, $f = 840$ MHz) No degradation	$P_{in(over)}$	—	—	0.4	W
Third Order Intercept Point ($V_{CE} = 24$ V, $I_C = 0.3$ A) ($f_1 = 900$ MHz, $f_2 = 900.1$ MHz, Meas. @ IMD 3rd Order = -40 dBc)	ITD	+43	+44.5	—	dBm
Noise Figure ($V_{CE} = 24$ V, $I_C = 0.3$ A, $f = 900$ MHz)	NF	—	5.25	—	dB
Input Return Loss ($V_{CE} = 24$ V, $I_C = 0.3$ A, $f = 840$ – 900 MHz, Power Output = 2.1 W)	IRL	—	-15	-10	dB

Table 1. MRF857S Common Emitter S-Parameters

V_{CE} (V)	I_C (A)	f (MHz)	S_{11}		S_{21}		S_{12}		S_{22}	
			$ S_{11} $	$\angle \phi$	$ S_{21} $	$\angle \phi$	$ S_{12} $	$\angle \phi$	$ S_{22} $	$\angle \phi$
24	0.3	800	0.915	165	2.098	54	0.037	58	0.343	-157
		820	0.915	165	2.049	53	0.038	58	0.345	-157
		840	0.915	165	1.991	52	0.038	58	0.349	-157
		860	0.913	164	1.951	51	0.039	59	0.352	-158
		880	0.914	164	1.912	50	0.040	59	0.355	-158
		900	0.914	163	1.865	49	0.041	59	0.359	-158
		920	0.913	163	1.832	48	0.042	59	0.362	-158
		940	0.915	162	1.783	47	0.043	59	0.366	-159
		960	0.916	162	1.748	46	0.043	59	0.369	-159

Table 2. Z_{in} and Z_{OL}^* versus Frequency

f (MHz)	Z_{in} (Ohms)		Z_{OL}^* (Ohms)	
840	1.5	4.4	18.4	-26.3
870	1.7	4.7	18.0	-26.1
900	1.5	4.8	14.9	-26.2

$$V_{CE} = 24 \text{ V, } I_C = 0.3 \text{ A, } P_O = 2.1 \text{ W}$$

Z_{OL}^* = Conjugate of optimum load impedance into which the device operates at a given output power, voltage and frequency.

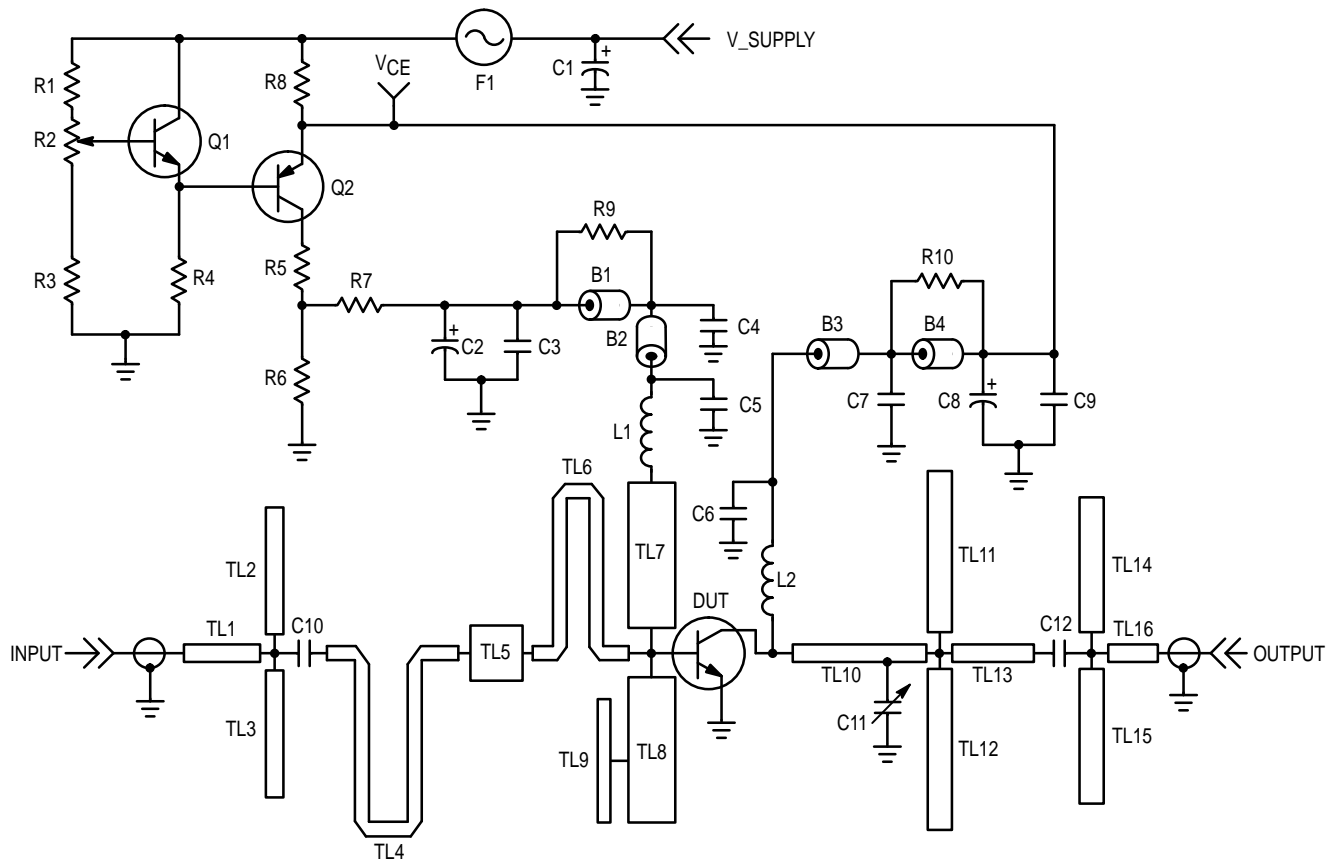

B1, B4	Long Ferrite Bead, Fair Rite (2743021447)	R1	330 Ω , 1/4 W
B2, B3	Short Ferrite Bead, Fair Rite (2743019447)	R2	500 Ω Potentiometer, 1/4 W
C1	250 μ F, 50 Vdc Electrolytic Capacitor	R3	4.7K Ω , 1/4 W
C2, C8	10 μ F, 50 Vdc Electrolytic Capacitor	R4	2 x 4.7K Ω , 1/4 W
C3, C9	0.1 μ F, Chip Capacitor	R5	47 Ω , 2 W
C4, C7	1000 pF, Chip Capacitor	R6	75 Ω , 1/4 W
C5, C6	100 pF, Chip Capacitor	R7	4.7 Ω , 1/4 W
C10, C12	43 pF, 100 Mil Chip Capacitor	R8	10 Ω , 3 W
C11	0.8–8 pF, Johansen Gigatrim	R9, R10	4 x 39 Ω , 1/8 W Chip Resistors in Parallel
F1	1 A Micro-Fuse	TL1–TL16	Microstrip Transmission Line
L1, L2	5 Turns, 20 AWG, 0.126" ID, 46.2 nH	V_Supply	+27 Vdc \pm 0.5 V Due to Resistor Tolerance
Q1	MMBT2222ALT1, NPN Transistor	V _{CE}	+24 Vdc @ 0.3 A
Q2	BD136, PNP Transistor	Board	0.030" Glass-Teflon [®] 2 oz. Cu, ϵ_r = 2.55

Figure 1. MRF857S Class A RF Test Fixture Schematic

TYPICAL CHARACTERISTICS

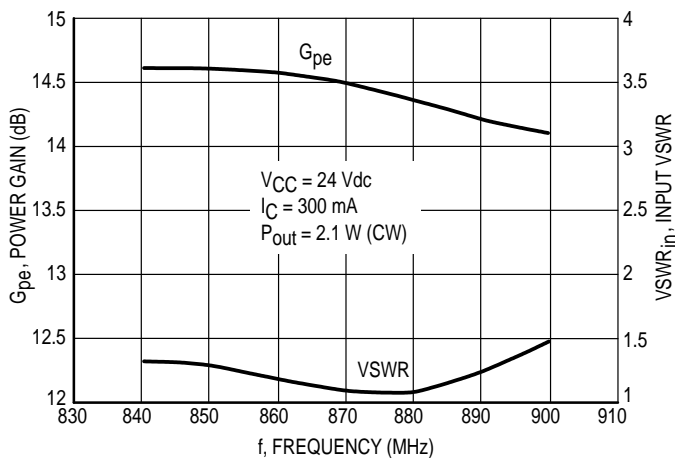

Figure 2. Performance of MRF857S in Broadband Circuit

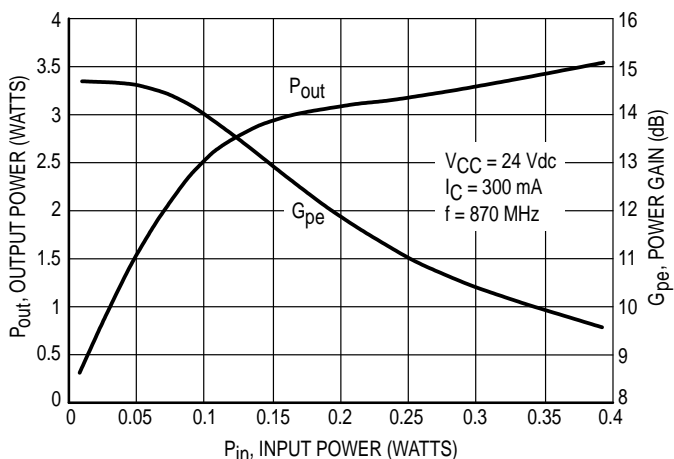

Figure 3. MRF857S Output Power & Power Gain versus Input Power

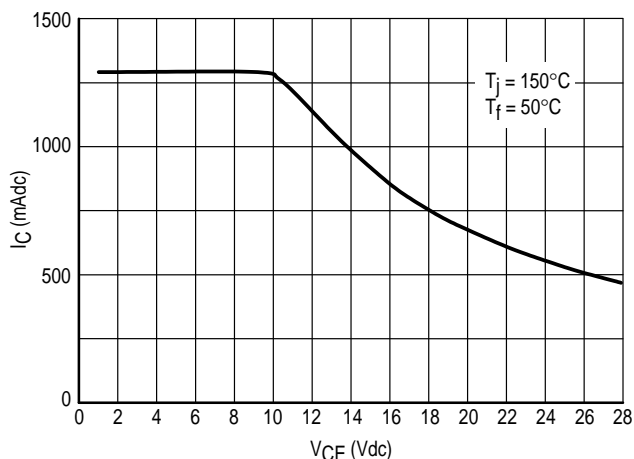

Figure 4. MRF857S DC SOA

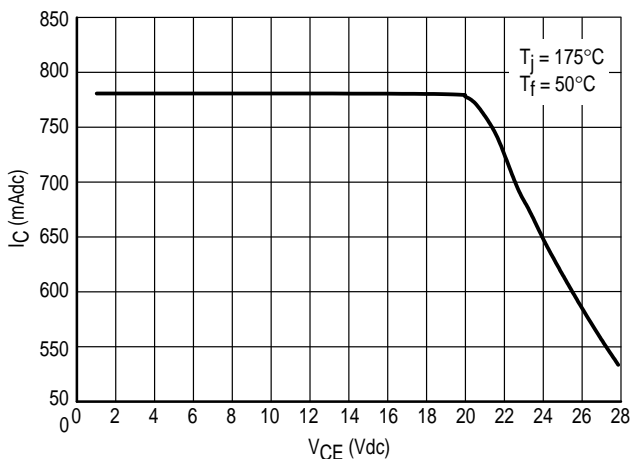

Figure 5. MRF857S DC SOA (This device is MTBF limited for $V_{CE} < 20$ Vdc.)

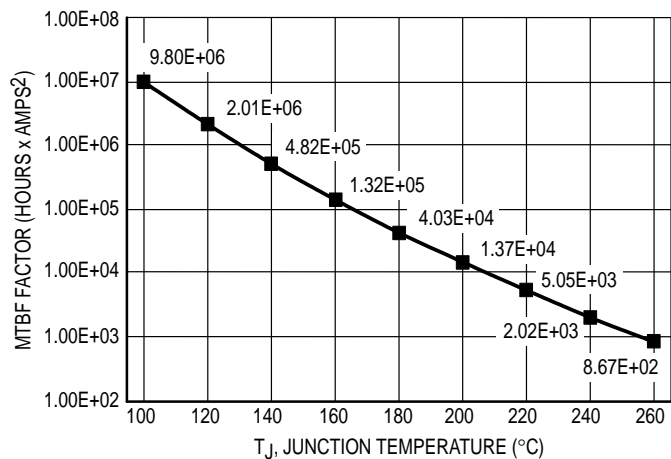

Figure 6. MRF857S MTBF Factor versus Junction Temperature

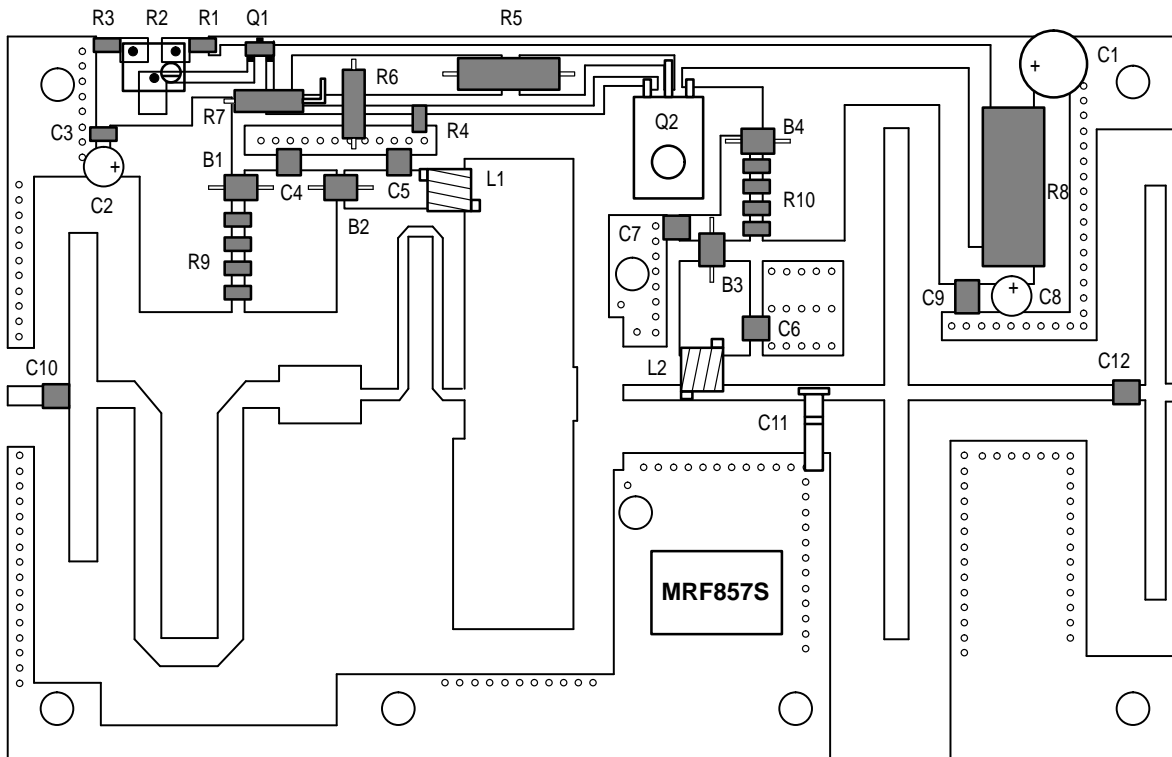
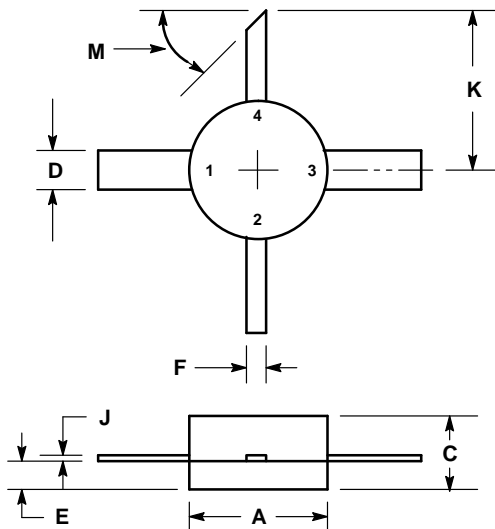

Figure 7. MRF857S Test Fixture Component Layout



- NOTES:
 1. DIMENSIONING AND TOLERANCING PER ANSI Y14.5M, 1982.
 2. CONTROLLING DIMENSION: INCH.

DIM	INCHES		MILLIMETERS	
	MIN	MAX	MIN	MAX
A	0.200	0.220	5.08	5.59
C	0.095	0.130	2.41	3.30
D	0.055	0.065	1.40	1.65
E	0.040	0.050	1.02	1.27
F	0.025	0.035	0.64	0.89
J	0.003	0.007	0.08	0.18
K	0.235	0.265	5.97	6.73
M	45° NOM		45° NOM	

- STYLE 1:
 PIN 1. EMITTER
 2. BASE
 3. EMITTER
 4. COLLECTOR

**CASE 305D-01
 ISSUE O**

Motorola reserves the right to make changes without further notice to any products herein. Motorola makes no warranty, representation or guarantee regarding the suitability of its products for any particular purpose, nor does Motorola assume any liability arising out of the application or use of any product or circuit, and specifically disclaims any and all liability, including without limitation consequential or incidental damages. "Typical" parameters which may be provided in Motorola data sheets and/or specifications can and do vary in different applications and actual performance may vary over time. All operating parameters, including "Typicals" must be validated for each customer application by customer's technical experts. Motorola does not convey any license under its patent rights nor the rights of others. Motorola products are not designed, intended, or authorized for use as components in systems intended for surgical implant into the body, or other applications intended to support or sustain life, or for any other application in which the failure of the Motorola product could create a situation where personal injury or death may occur. Should Buyer purchase or use Motorola products for any such unintended or unauthorized application, Buyer shall indemnify and hold Motorola and its officers, employees, subsidiaries, affiliates, and distributors harmless against all claims, costs, damages, and expenses, and reasonable attorney fees arising out of, directly or indirectly, any claim of personal injury or death associated with such unintended or unauthorized use, even if such claim alleges that Motorola was negligent regarding the design or manufacture of the part. Motorola and  are registered trademarks of Motorola, Inc. Motorola, Inc. is an Equal Opportunity/Affirmative Action Employer.

Mfax is a trademark of Motorola, Inc.

How to reach us:

USA/EUROPE/Locations Not Listed: Motorola Literature Distribution;
 P.O. Box 5405, Denver, Colorado 80217. 303-675-2140 or 1-800-441-2447

JAPAN: Nippon Motorola Ltd.: SPD, Strategic Planning Office, 4-32-1,
 Nishi-Gotanda, Shinagawa-ku, Tokyo 141, Japan. 81-3-5487-8488

Mfax™: RMFAX0@email.sps.mot.com – TOUCHTONE 602-244-6609
 – US & Canada ONLY 1-800-774-1848

ASIA/PACIFIC: Motorola Semiconductors H.K. Ltd.; 8B Tai Ping Industrial Park,
 51 Ting Kok Road, Tai Po, N.T., Hong Kong. 852-26629298

INTERNET: <http://motorola.com/sps>

